

# IT7900P High Performance Regenerative Grid Simulator

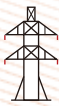

E-mobility



Grid



Energy Storage



Photovoltaic



IEC Testing



*Your Power Testing Solution*

# IT7900P High Performance Regenerative Grid Simulator



Adopting advanced SiC technology, the IT7900P series high-performance Regenerative grid simulator provides an all-in-one test solution that can be used not only as a grid simulator and four-quadrant power amplifier, but also as a four-quadrant regenerative AC/DC electronic load. The full four-quadrant operation, regenerative ability can feedback power to the grid, meet the needs of environmental protection, but also save a lot of electricity and heat dissipation costs. Compact, modular and efficient structure design allows the IT7900P up to 15kVA in 3U single unit, and its power can be extended to 960kVA after master-slave parallel connection. Colorful touch screen with intuitive GUI allows IT7900P to directly define different waveforms. The rich operation modes can meet the test requirement of single-phase, three-phase, reversed phase(split phase) and multi-channel. It provides high flexibility for testing and can be widely used in many fields such as PV, ESS and EV.



## ESS

PCS energy storage converters, microgrids, home PV energy storage devices



## Power Electronics

Uninterruptible Power Supply System (UPS), AC power supply, inverter Generators, transformers, AC fans



## PV

Photovoltaic inverters, power conditioning systems



## Electronic Components

Circuit breakers, fuses, connectors

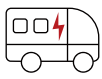

## EV

V2G, V2X, EVSE, vehicle type converters, electric vehicle power supply



## Scientific research, universities, laboratories, certification bodies

AC-DC power adapter testing, electromagnetic compatibility testing

Model	Output voltage		Output current		Output power	Phase	Size
	V L-N	V L-L	Arms(1Φ)	Arms(3Φ)			
IT7905P-350-30U	350V	—	30A	—	5kVA	1Φ	3U
IT7906P-350-90	350V	606V	90A	30A	6kVA	1Φ,3Φ,reversed phase	3U
IT7909P-350-90	350V	606V	90A	30A	9kVA	1Φ,3Φ,reversed phase	3U
IT7912P-350-90	350V	606V	90A	30A	12kVA	1Φ,3Φ,reversed phase	3U
IT7915P-350-90	350V	606V	90A	30A	15kVA	1Φ,3Φ,reversed phase	3U
IT7930P-350-180	350V	606V	180A	60A	30kVA	1Φ,3Φ,reversed phase	6U
IT7945P-350-270	350V	606V	270A	90A	45kVA	1Φ,3Φ,reversed phase	15U
IT7960P-350-360	350V	606V	360A	120A	60kVA	1Φ,3Φ,reversed phase	27U
IT7975P-350-450	350V	606V	450A	150A	75kVA	1Φ,3Φ,reversed phase	27U
IT7990P-350-540	350V	606V	540A	180A	90kVA	1Φ,3Φ,reversed phase	27U
IT79105P-350-630	350V	606V	630A	210A	105kVA	1Φ,3Φ,reversed phase	27U
IT79120P-350-720	350V	606V	720A	240A	120kVA	1Φ,3Φ,reversed phase	37U
IT79135P-350-810	350V	606V	810A	270A	135kVA	1Φ,3Φ,reversed phase	37U
IT79150P-350-900	350V	606V	900A	300A	150kVA	1Φ,3Φ,reversed phase	37U
IT79165P-350-990	350V	606V	990A	330A	165kVA	1Φ,3Φ,reversed phase	37U

# Your Power Testing Solution

## IT7900P High Performance Regenerative Grid Simulator

### Parameter Features

- Adopt advanced SiC technology
- High power density, 15 kVA for 3U
- Voltage can reach 350V L-N
- Master and slave equal flow, parallel machines up to 960kVA \*1
- Highly efficient power regeneration power accumulation function
- Comprehensive working modes selectable: single-phase, three-phase, reversed phase(split phase) and multi-channel, Voltage extension to 200% of rated voltage in inverted mode
- Support LIST/SWEEP/Surge&Sag three waveform modes
- Built-in rich waveform database
- Harmonic simulation and analysis function up to 50 times,built-in IEC61000-3-2/3-12 \*2
- Can simulate arbitrary waveform output, support CSV file import waveform
- Phase angle 0-360° settable
- Touch screen design, simple UI interface
- Built-in USB/CAN/LAN /Digital IO interface,optional GPIB/analog & RS232 interface
- Full protection functions including automatic clearing, POVP, watchdog, etc.
- Current source mode
- Support CANopen, Modbus, LXI, SCPI communication

### Source Features

- Regenerative grid simulator & full 4-Quadrant AC&DC power sources
- Frequency: 16-2400Hz \*4
- Power Amplifier function for PHIL applications
- Professional islanding test mode, support R, L, C and active, reactive power settings\*7
- Four output modes of AC/DC/AC+DC/DC+AC can be realized
- Multi-channel function, single unit can test 1-3 DUTs at the same time \*5
- Programmable output impedance,simulation of real-world impedance
- Harmonic/inter harmonic synthesis
- Frequency lock and phase lock function to achieve 6 phase& 12 phase power output
- Compliance tests incl. LVRT /Phase Jump/Frequency variation/harmonic injection
- Supported regulatory testing include IEC61000-4-11/4-13/4-14/4-17/4-28/4-29
- Provide rich trigger configuration, synchronous capture of the voltage waveform of the object to be measured, to achieve data acquisition and simulation functions
- Optional software can help complete the pre-compliance standards test of civil avionics/electrical ships interms of the multi-national safety regulations. \*3

### Load Features

- Regenerative full 4-Quadrant AC&DC load
- Frequency: 16-500Hz
- In AC mode, it supports multiple working modes: CC/CP/CR/CS/CC+CR/CE.
- In CE mode, it can simulate 14 circuit topologies, including single-phase rectifier RLC and parallel RLC.
- DC mode supports 9 working modes such as CC/CR/CP/CV
- AC mode supports both rectified and non-rectified modes
- Adjustable crest factor: 1.414 ~ 5.0
- Support phase shift function in the range of -180°~180° \*6
- The unit power factor1 function allows the current waveform to vary with the voltage waveform and the power factor is as close to 1 as possible
- Supporting unloading angle control, 0-359° adjustable

\*1 For 1U/2U models, max.16 units can be parallel connected, for 3U models max. 64 units can be parallel connected.

\*2 Voltage/current harmonic analysis, voltage harmonic simulation in source mode, current harmonic simulation in load mode, fundamental waves≤60Hz

\*3 Stay tuned

\*4 In grid simulator and island simulation mode, 16~150Hz

\*5 Not available for single-phase models

\*6 After the rectification function is turned on, the setting range of the phase shift is restricted by the crest factor

\*7 Not available for multi-channel mode



# Your Power Testing Solution

## IT7900P High Performance Regenerative Grid Simulator

01

### All in one unit

IT7900P series integrates 3 products, a grid simulator(IT7900), an AC/DC power supply (IT7800) and a regenerative AC/DC load (IT8200).

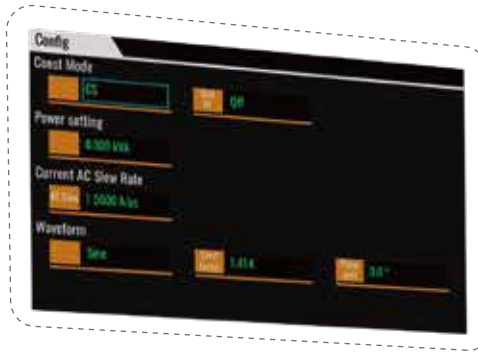

02

### High power regeneration efficiency

Whether it is used as a grid simulator or a load, in AC or DC mode, the IT7900P is high efficiently power regenerative. The energy generated by the DUT can be fed back to the local grid instead of dissipating in the form of heat, which is good for energy-saving and environment protection.



03

### High power density

The IT7900P series can be both 3U stand-alone unit and 15U/27U/37U cabinets. It can meet the test requirements of 5k~165kVA. Among them, the size of the 3U/15kVA model is only 1/12 of the ordinary AC power supply on the market, which can be placed on your test bench, largely saves your room.



# Your Power Testing Solution

## IT7900P High Performance Regenerative Grid Simulator

04

### Various test items

Sliding the touch screen of the IT7900P series is as simple as operating a mobile phone. The intuitive GUI not only allows multiple parameters displayed at the same time, but also multiple display ways are selectable, such as waveform graph, histogram, vector diagram and list.

05

### Multiple protection and communication interfaces

IT7900P series has a variety of protection functions to ensure the safety of the test, including: over-current Rms protection, over current peak protection, over temperature protection, automatic clear protection, software watchdog and so on. IT7900P not only has built-in USB/CAN/LAN/digital IO interfaces, but also provides optional GPIB/analog & RS232.

06

### Power extension by master-slave parallel connection

Through the master-slave parallel connection, the power of IT7900P can be extended up to 960kVA. It can be easily paralleled without disassembling and assembling the cabinet, and the multi-modules can synchronously share the current output. Not only will it retain all functions after paralleling, but there will be no precision sacrifice.



# Your Power Testing Solution

## IT7900P High Performance Regenerative Grid Simulator

### Outstanding Features

#### 4-Quadrant output

IT7900P series is not only a full four-quadrant power grid simulator, but also a full four-quadrant AC/DC electronic load. It can operate in all four quadrants. The efficient energy regeneration function makes it good for testing the frequency change of grid-connected PV inverters, voltage transients and anti-islanding protection.

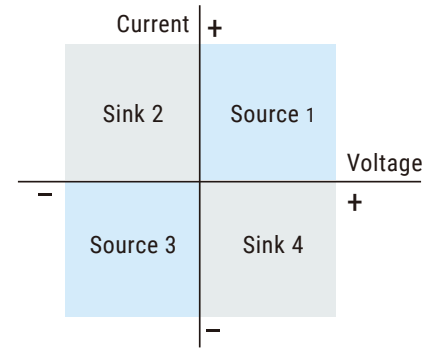

#### Full 4-Quadrant Power Amplifier

The IT7900P series regenerative grid simulator can be used as a power amplifier to complete power hardware in the loop (PHIL) applications for microgrids, energy storage and new energy vehicles. The digital I/O or a standard suite of analog signal can be input via an external analog interface (optional) and then amplified without distortion to a real power waveshape with delay  $\leq 65\mu s$ .

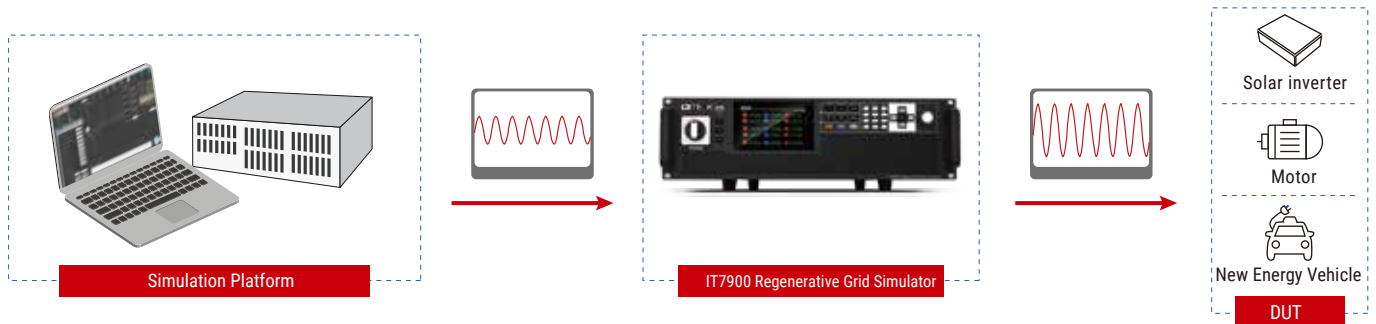

#### Professional Anti-islanding Test Mode

Anti-islanding protection is one of the must-test items for grid-connected inverters. IT7900P series has built-in anti-islanding protection test function, which allows testers to set the active power of resistor R, the reactive power of inductor Q and capacitor C, and also set resistor R, inductor Q, and capacitor C to simulate the inter-network resonance and test the anti-island protection function of grid-connected inverter. IT7900P is land test mode can simplify the test process, improve test efficiency, and complete the test of the anti-islanding protection function in the process of grid-connected inverter research and development test, factory inspection, etc.

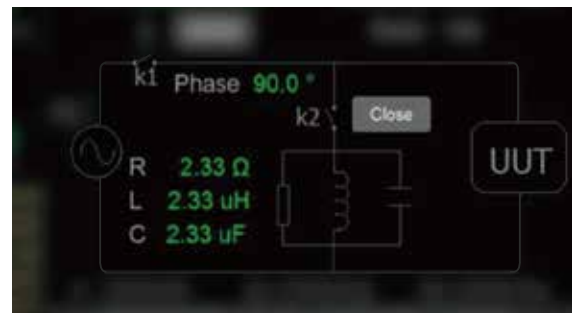

#### Pre-compliance regulation test

According to industry standards, IT7900P series has built-in regulation standards such as IEC61000-4-11/4-13/4-14/4-17/4-28/4-29, IEC61000-3-2/3-12. These regulations can be recalled directly. You can also customize the test items required by regulations too.

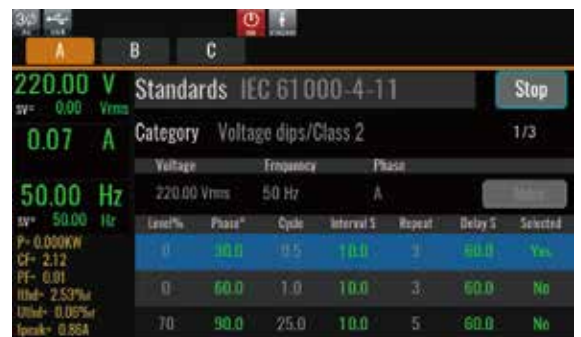

# Your Power Testing Solution

## IT7900P High Performance Regenerative Grid Simulator

### IT7900P High Performance Regenerative Grid Simulator

#### AC/DC load conditions emulation

##### DC load mode

	Constant Voltage (CV)
	Constant Current (CC)
	Constant Resistance (CR)
	Constant Power (CP)
	CC+CV
	CR+CV
	CP+CV
	CC+CR
	CP+CV+CR+CC

##### AC load mode

	Constant Current (CC)
	Constant Resistance (CR)
	Constant Power (CP)
	Constant apparent power (CS)
	CC+CR
	CE RLC

Simulate 14  
circuit topologies

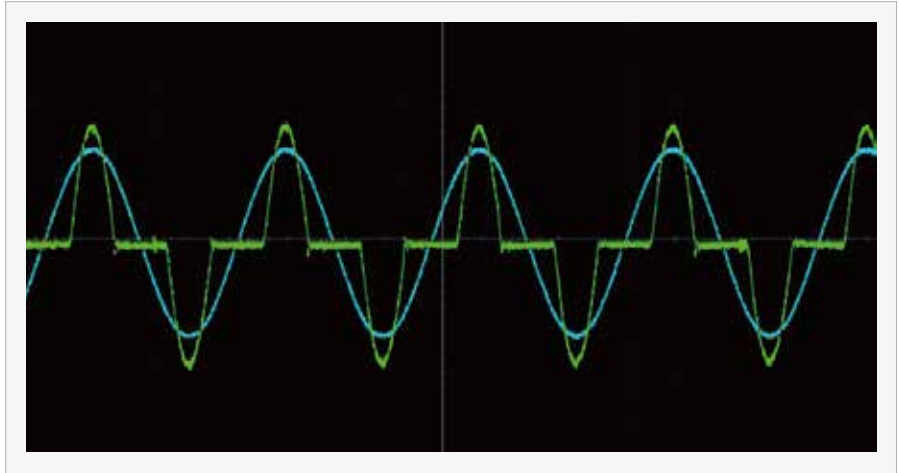
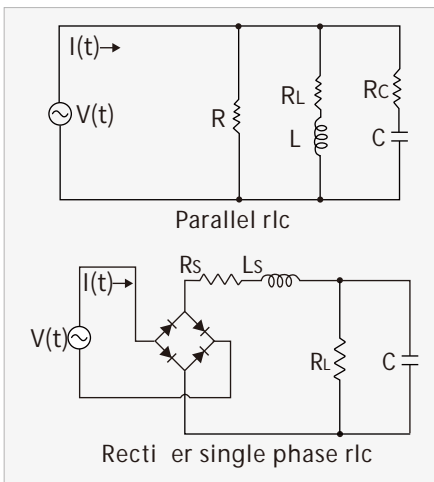

IT7900P AC electronic load can enable the 'Rectified' function in AC mode, so that the load works in the first and third quadrants to ensure that the voltage and current flow always in the same direction. At this time, full wave, positive half wave, or negative half wave can be freely selected.

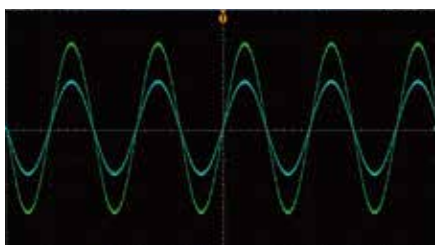

full wave

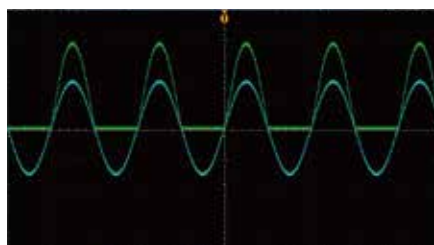

positive half wave



negative half wave

# Your Power Testing Solution

## IT7900P High Performance Regenerative Grid Simulator

### CF 1.414-5.0

The crest factor indicates the extreme peaks of the waveform. For applications that require a pure sine wave, it is desirable to have a CF value of the load current waveform of 1.414 or as close as possible. However, in practical applications, the peak shape of the current waveform of the load may become very sharp and its CF is often higher than 1.414. At this time, the starting point of the sine wave starts to shift from 0 degrees to the positive degree. So you need to correct the waveform. The Crest Factor of the IT8200 can be adjusted from 1.414 to 5.0, and it also allows to set the phase shift angle from  $-90^{\circ}$  to  $90^{\circ}$ , correct the resulting amplitude, and keep the RMS unchanged. This enables more accurate simulation of field test conditions to ensure the reliability of the unit under test (UUT).

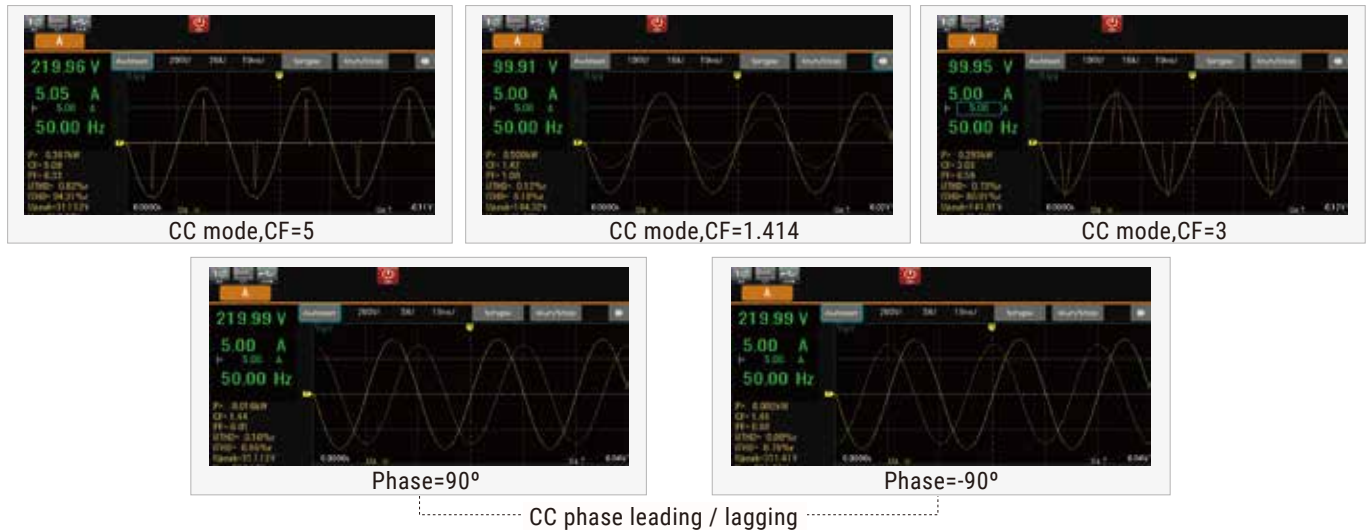

## Multiple operation modes

### AC,DC,AC+DC,DC+AC working mode

IT7900P series can be used as a "full four-quadrant AC/DC power supply" and provides four output modes: AC, DC, AC+DC, and DC+AC. Not only provide pure AC/DC output, use AC+DC and DC+AC output modes to realize "AC output superimposed DC bias" and simulate "DC output waveform with ripple" to meet the complex application requirements of engineers. In DC mode, the rated power in 100% AC mode can be achieved.

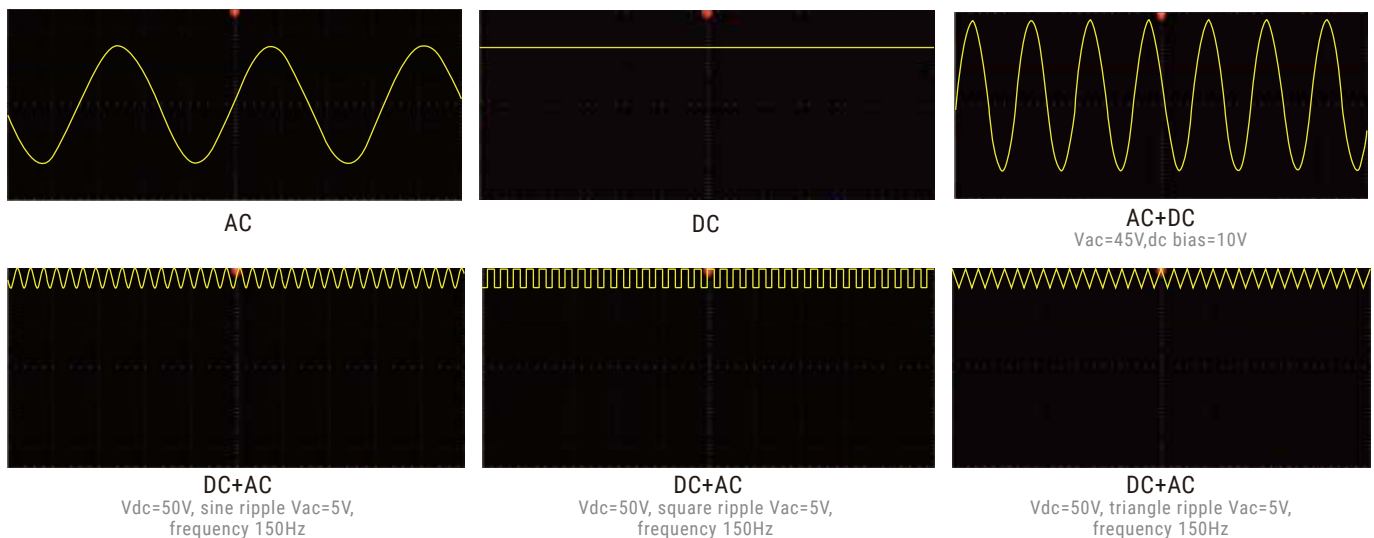



# Your Power Testing Solution

## IT7900P High Performance Regenerative Grid Simulator

### Single-phase, three-phase, reverse phase(split phase), multi-channel operation modes

IT7900P series has very flexible operation mode that single-phase, three-phase/ reverse phase(split phase) /multi-channel output mode can be selected. Combined with the powerful programming function, it can simulate three-phase unbalance, phase loss and phase sequence reverse connection and so on. In the reverse phase(split phase) mode, users can obtain a single-phase output voltage of up to 700V, and the power remains at 2/3 of the original. Multi-channel mode allows users to test 1-3 independent DUT at the same time. One device for multiple purposes, better equipment utilization, and reduces test costs for enterprises.

IT7900P Operation Mode		
CH1 (1-Phase)	CH2 (1-Phase)	CH3 (1-Phase)
1-Phase		
reverse phase(split phase)		
3-Phase		

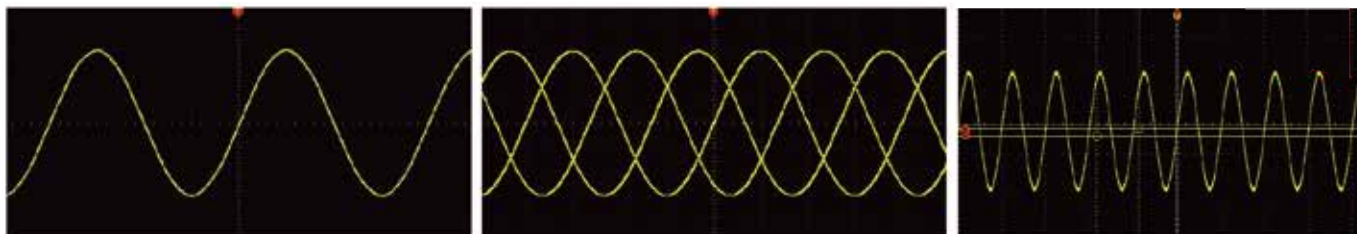

### Frequency lock/phase lock function, multi-phase output or high voltage output

IT7900P series can realize frequency locking and phase locking between power supplies through optical fiber, simulating 6-phase and 12-phase power output. It can not only keep the set value updated synchronously, but also has multi-phase protection to meet the complex AC test requirements. This also helps to realize high-voltage tests up to 1400Vrms 3 phase. Via the digital IO interface, it can also be used for simple multi-phase system applications.

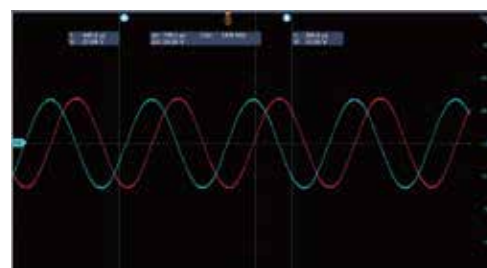

phase lock, 2400Hz

## Measurement Functions

### Data acquisition and simulation

IT7900P series integrates an advanced data acquisition system based on digital signal processor, and provides measurement and waveform analysis functions of a digital oscilloscope, a power meter and a digital multimeter. Its current measurement accuracy is as high as 0.1%+0.2%FS, and the voltage measurement accuracy is as high as 0.1%+0.1%FS. 6 oscilloscope curves can be displayed at the same time, which not only saves the cost, but also saves the time for wiring connection. The trigger configuration of IT7900P can synchronously capture the voltage waveform of the DUT, and realize the functions of data acquisition and simulation. The user can import the collected abnormal voltage data of the power grid into the IT7900P to reproduce the power grid status, set the repetition times, offset and other parameters of the waveform.

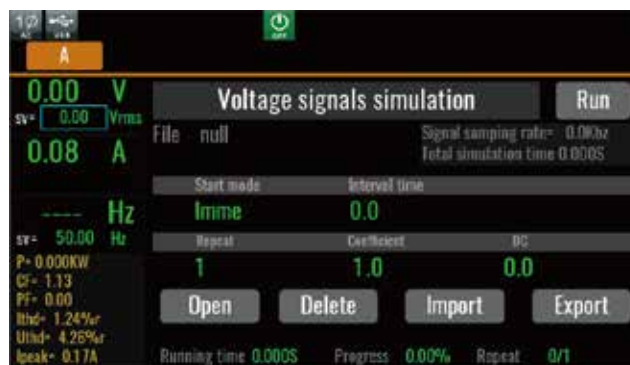
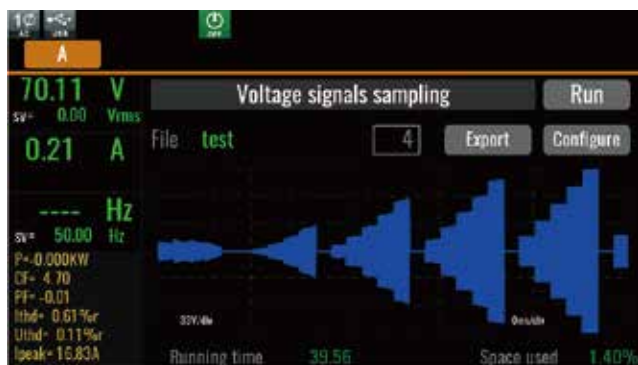

# Your Power Testing Solution

## IT7900P High Performance Regenerative Grid Simulator

### Data record

Thanks to the function of large data recording, IT7900P series is capable of recording up to 7 hours of continuous data at short intervals (fastest: 100ms). And it's easy to view the complete curve generating from the start to the end of the test. There are six curves that can be displayed at the same time at most. In addition, you can slide the vernier calipers on the screen to check the exact data at a particular point in the current trend curves. It is useful for analyzing errors during test for a long time or inflection points during loading, etc. Besides, you can export the test data for further analysis by front panel USB interface.



### Harmonic analysis

Harmonic analysis functions include both voltage and current harmonic measurement. In the harmonic mode, the voltage and current total harmonic distortion (THD) and the phase difference test of the harmonic to the fundamental wave can be realized. In addition, you can make multiple harmonic measurements. The test results are displayed in a list, histogram or vector diagram, easy to check.

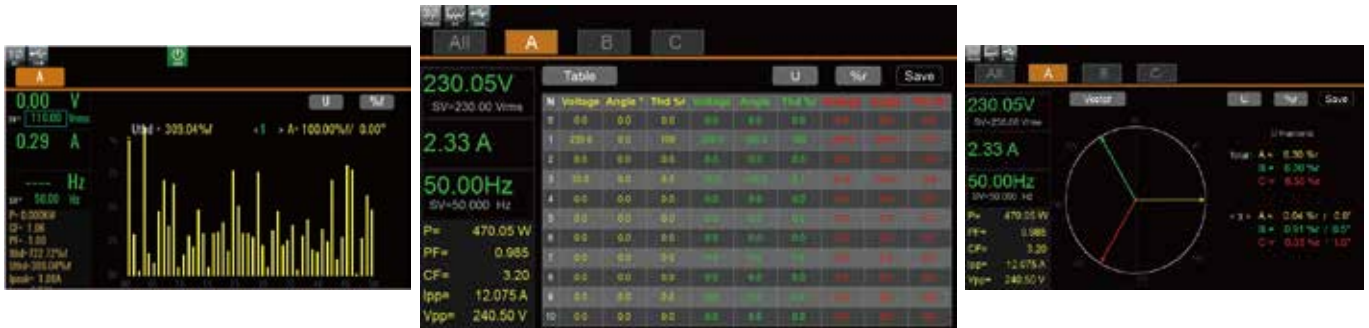

### Current Source Mode

The IT7900P series has a current source mode. It can operate in various modes such as single-phase, reverse phase(split phase), AC and AC+DC. Its maximum voltage can reach 700V, which can meet various high voltage and high current applications. Meanwhile, the Normal and LIST functions can cope with various types of conventional and dynamic testing requirements. The rich waveform editing and customization functions can also help you simulate complex current waveforms.

Current source mode can provide stable current output so that you can simulate various loads, such as laser drivers, LEDs, motors, etc. With a maximum frequency of 2400Hz, it can quickly do frequency sweep, charge/discharge, AC impedance and other related tests on various types of batteries. While improving test efficiency and accuracy, the IT7900P also optimizes the system design while ensuring safety.

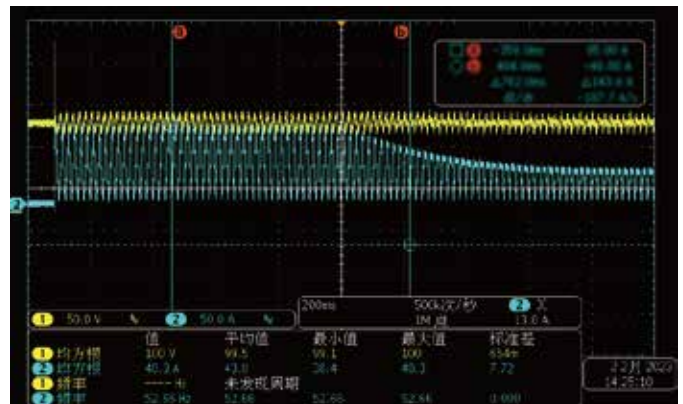

AC+DC, AC20A+ DC30A, 50Hz; limit current 10A, enter current loop

### Powerful waveform editing function

#### Built-in various type of distorted waveforms

In addition to sine waveform, IT7900P series provides various standard AC waveforms, such as triangular wave, sawtooth wave, square wave, trapezoidal wave and clipped sine wave. These waves can be easily recall from the menu and displayed in the LCD touch screen. Moreover, in combination with sequence programming function, users can realize multiple waveform continuous output, to cope with complex power line disturbance test.



#### User-defined waveform function

IT7900P series provides user-defined waveform editing function that allows users to simulate the effects of real AC or DC power supply systems on DUT's in different test environments by importing real waveform data into the device, it supports up to 1024 points of data import.

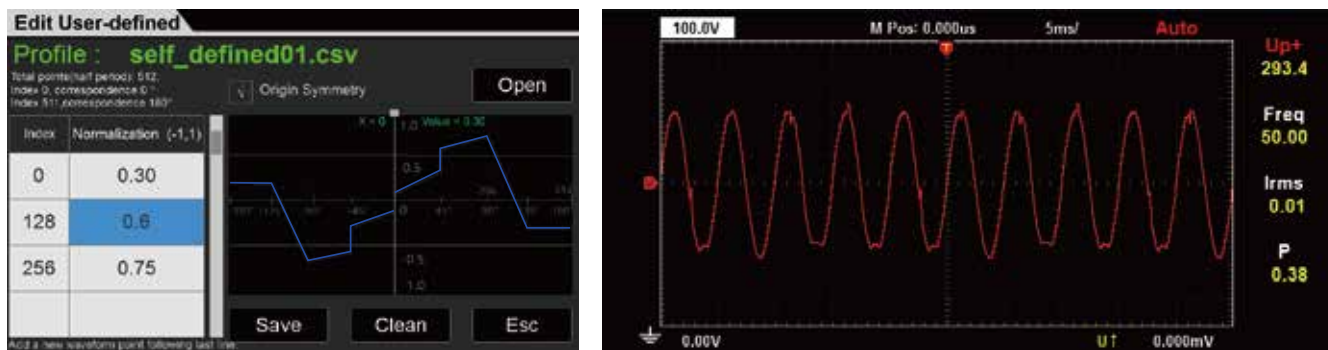

#### Simulate power grid and low voltage ride through (LVRT) testing

Low voltage ride-through refers to the ability of the power generation system to continue to operate without disconnecting from the grid within a certain range of voltage drop when the grid fault or disturbance causes a voltage drop, and even provides a reactive power to help the system recover the voltage. You can edit the test parameters under LVRT condition. With the fast response, it can fully meet the test requirements of LVRT. At the same time, the IT7900P series has the function of arbitrary waveform. With the LIST function, it can edit and simulate various grid disturbance waveforms through the panel or software, such as instantaneous power failure, surge and voltage rise and fall.

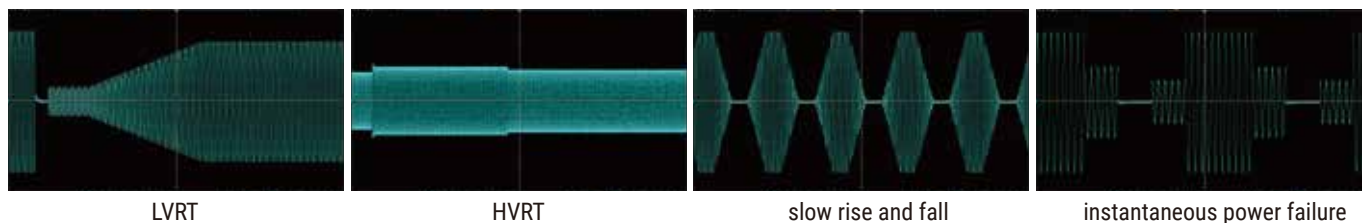

# Your Power Testing Solution

## IT7900P High Performance Regenerative Grid Simulator

### Harmonic and inter-harmonic simulation

With high-speed DSP technology, IT7900P series is capable of simulating harmonic, inter-harmonic and harmonic synthesis. By setting the amplitude and phase, it can simulate up to 50th harmonics(fundamental frequency is 50Hz or 60Hz), creating a periodic distortion waveform. It also has built-in 30 types harmonic distortion waveforms for quick recall. Harmonic test is one of the important tests for EMC immunity, and single-phase harmonics, three-phase harmonics and three-phase harmonic unbalance output can be realized,also meet IEC regulations test requirements.

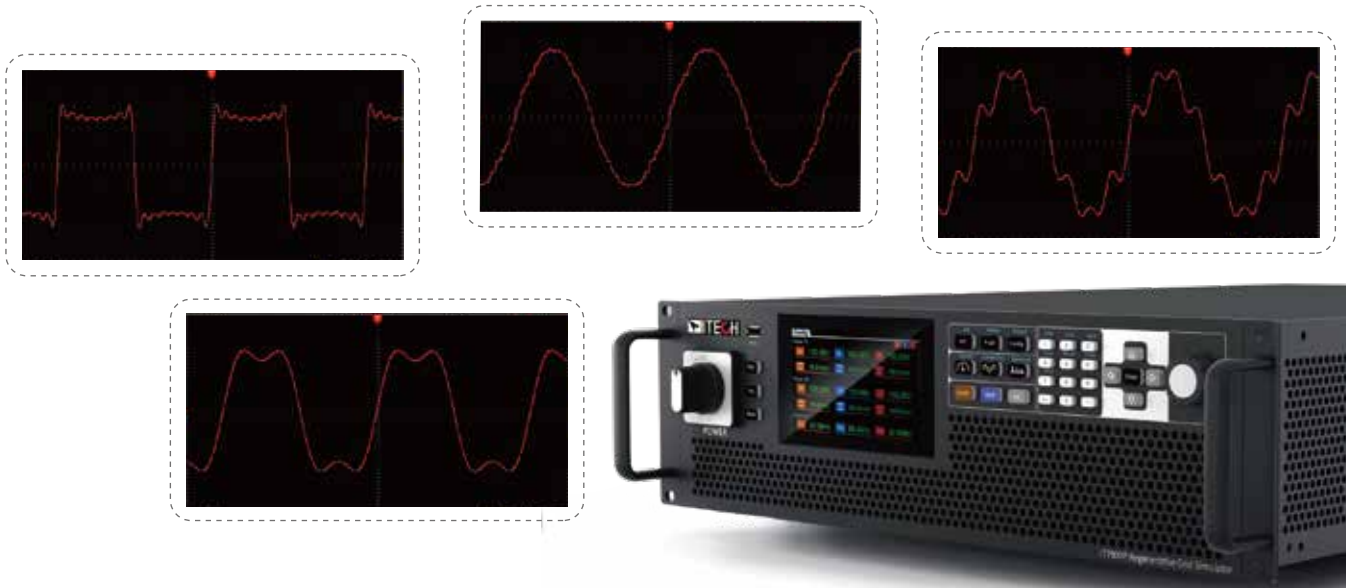

### LIST/SWEEP/Surge & Sag modes

IT7900P series supports NORMAL,LIST and SWEEP mode. Each mode can work with Surge&Sag function.

- In LIST mode, a single file supports up to 200 steps, and the waveform type, voltage, frequency, slope and start-stop phase angle can be selected under each step. When the output voltage or frequency jumps, a trigger signal can be generated to synchronize external devices, which is especially suitable for large-scale test platforms with strict logic control and fast response for inter-device linkage.
- SWEEP is suitable for AC mode, which can test the efficiency of switching power supply, grab the voltage and frequency of the maximum power point, and change the setting parameters in a step-by-step way.
- In NORMAL/LIST/SWEEP modes, Surge&Sag can work with each of them. The surge and sag can be controlled by trigger or cycle, and the starting angle of the drop can be set, and waveform smoothing, symmetrical and asymmetrical waveform operations are supported. Waveforms can be quickly created to replicate waveform distortions or transient status such as spikes, dropouts, or any other anomalies that can be seen as a single cycle.

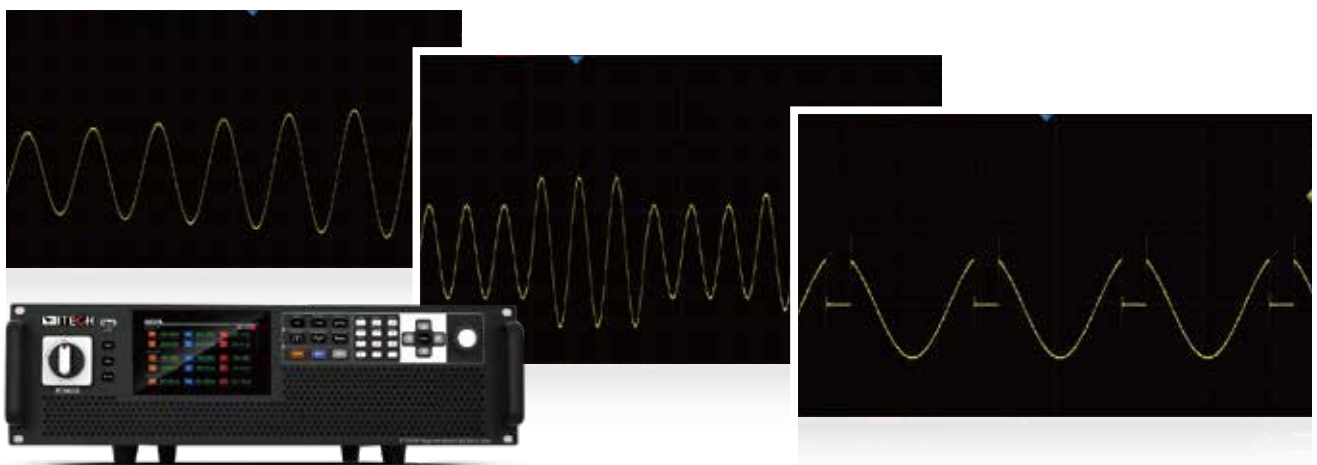

# Your Power Testing Solution

## IT7900P High Performance Regenerative Grid Simulator

### Intuitive software interface

IT7900Pseries provides free PC software PV7900P with an intuitive GUI. Meanwhile, it allows remote control, even the ATE models without display screen can be programmed, communicated and monitored.

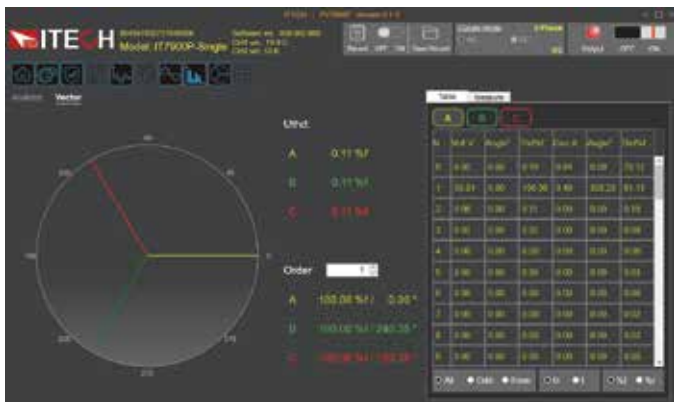
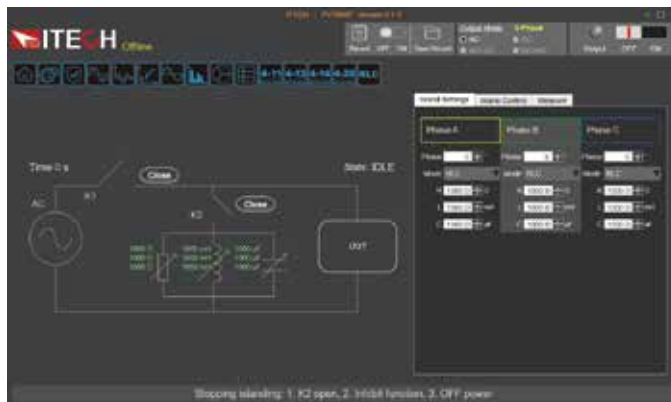
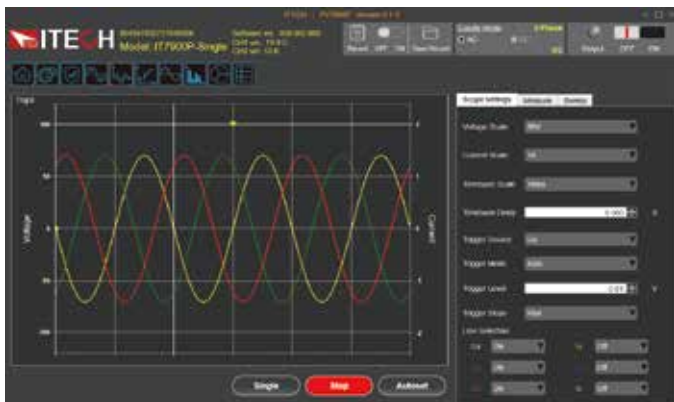

### Optional Accessories

Item	Model	Specification	Description
Parallel kit	IT-E510-15U *1	15U unit, grey	800mm X 550mm X907.64mm
	IT-E511-15U *1	15U unit, black	800mm X 550mm X907.64mm
	IT-E510-27U *1	27U unit, grey	800mm X 600mmX 1441.41mm
	IT-E511-27U *1	27U unit, black	800mm X 600mmX 1441.41mm
	IT-E510-37U *1	37U unit, grey	800mm X 600mm X 1885.91mm
	IT-E511-37U *1	37U unit, black	800mm X 600mm X 1885.91mm
	IT-E168	fiber kit for parallel	for single unit
	IT-E169	fiber kit for parallel	for cabinet
Other accessories	IT-E258	power cord for 3U unit, 5m, US standard	AC input power cord
	IT-E258-15U	power cord for 15U cabinet, 5m, US standard	AC input power cord
	IT-E258-27U	power cord for 27U cabinet, 5m, US standard	AC input power cord
	IT-E258-37U	power cord for 37U cabinet, 5m, US standard	AC input power cord
	IT-E176	GPIB	
	IT-E177	RS232 & analog	

\*1 There is standard cabinet for models >30kVA



IT-E511-27U

Input parameters (connect to grid)			
AC Input	Wiring connection	3 phase 3wire + ground(PE)	
	Line voltage	RMS (200V ~ 220V) ±10% *1 (380V ~ 480V) ±10%	
	Line current	RMS < 34A	
	Apparent power	< 17.4kVA	
	Frequency	45 ~ 65Hz	
	Power factor	typ 0.98	
Output parameters (connect to EUT) (connect to grid)			
AC Output	Output voltage	VLN *2 VLL 0 ~ 606V (3phase) / 0 ~ 700V (reverse)	
	Output current	RMS	90A (1phase) / 30A (3phase/multichannel/reverse)
		Crest Factor *3	6
		Peak	270A (1phase) / 90A (3phase/multichannel/reverse)
	Output power	Per Phase/Per Channel	5kVA
		Max. Power	10kVA (reverse phase) / 15kVA (1phase/3phase/multichannel)
	Voltage setting		
	Range	0 ~ 350V (1phase/3phase/multichannel) / 0 ~ 700V (reverse)	
	Resolution	0.01V	
	Accuracy	< 0.1%+0.1% F.S. (16Hz ~ 500Hz) / < 0.1%+(0.2%*kHz)F.S. (500.01Hz ~ 2.4kHz)	
	DC offset voltage	typ	0.02Vdc
	Current Limit setting		
Range	RMS 90A (1phase) / 30A (3phase/multichannel/reverse)		
Resolution	0.01A		
Accuracy	< 0.1% + 0.2% F.S. (16Hz ~ 150Hz) / < 0.2% + 0.3% F.S. (150.01Hz ~ 500Hz) / < 0.3%+(0.6%*kHz) F.S (500.01Hz ~ 2.4kHz)		
Frequency			
Range	16 ~ 500Hz (Low *4) / 16 ~ 2.4k (High *4)		
Resolution	0.01Hz		
Accuracy	0.01% (16Hz ~ 500Hz) / 0.1% (500.01Hz ~ 2.4kHz)		
waveform synthesis	50/60Hz	up to 50 orders	
Phase			
Range	0 ~ 360°		
Resolution	0.01°		
DC Output	Voltage setting		
	Range	-499 ~ 499Vdc (1phase/multichannel) / -998 ~ 998Vdc (reverse)	
	Resolution	0.01V	
	Accuracy	< 0.1%+0.1% F.S	
	Current setting		
	Range	-30 ~ 30Adc (multichannel/reverse) / -90 ~ 90Adc (1phase)	
	Resolution	0.01A	
	Accuracy	< 0.1% + 0.2% F.S.	
	Max. power		
	Phase power	Per Channel	5kW
	Max. power (reversephase)	Max. Power (reverse phase)	10kW
	Total power	Max. Power (1phase/multichannel)	15kW
Voltage stability	Line regulation	< 0.05% F.S.	
	Load regulation*5	< 0.05% + 0.05% F.S.(DC,16Hz ~ 500Hz) / < 0.05% + (0.1%*kHz) F.S(500.01Hz ~ 2.4kHz)	
	THD*6	< 0.5%(16Hz ~ 100Hz) / < 1%(100.01Hz ~ 500Hz) / < 1%+(1%*kHz) F.S.(500.01Hz ~ 2.4kHz)	
	Voltage ripple	RMS	< 0.4V
	Dynamic response*7	typ	200us
Programmable impedance	R Range	0 ~ 1000mΩ(3phase/multichannel) / 0 ~ 333.333mΩ (1phase) / 0 ~ 2000mΩ(reverse)	
	L Range	0 ~ 1000uH (3phase/multichannel) / 0 ~ 333.333uH (1phase) / 0 ~ 2000uH (reverse)	
RLC	P Range	0 ~ 5kW (3phase) / 0 ~ 15kW (1phase) / 0 ~ 10kW (reverse)	
	QL Range	0 ~ 5kVar (3phase) / 0 ~ 15kVar (1phase) / 0 ~ 10kVar (reverse)	
	QC Range	0 ~ 5kVar (3phase) / 0 ~ 15kVar (1phase) / 0 ~ 10kVar (reverse)	
	R Range	1 ~ 1000Ω (3phase) / 0.333 ~ 333.333Ω (1phase) / 2 ~ 2000Ω (reverse)	
	L Range	1 ~ 5000mH (3phase) / 0.333 ~ 1666.667mH (1phase) / 2 ~ 10000mH (reverse)	
	C Range	0.001 ~ 5mF (3phase) / 0.003 ~ 15mF (1phase) / 0.001 ~ 2.5mF (reverse)	
Voltage Slew Rate, Typical	≥2 V/μs with full-scale programmed voltage step		
Output Isolation	550Vac		
Output parameters (electronic load mode)			
AC Mode	Input voltage	VLN VLL 51.96 ~ 606V (3phase) / 30 ~ 700V (reverse)	
	Input frequency	16~500Hz	
	Input current	RMS	90A (1phase) / 30A (3phase/multichannel/reverse)
		Crest Factor *8	5
		Peak	270A (1phase) / 90A (3phase/multichannel/reverse)
	Input power	Per Phase	5kVA (3phase)
		Max. Power	10kVA (reverse phase) / 15kVA (1phase/3phase/multichannel)
	CC Mode		
	Current Range	RMS 90A (1phase) / 30A (3phase/reverse)	
	Resolution	0.01A	
	Accuracy*9	< 0.1% + 0.2% F.S. (DC,16Hz ~ 150Hz) / < 0.2% + 0.3% F.S.(150.1Hz ~ 500Hz *10)	
	CP Mode		
Range	Max. Power	15kW (1phase/3phase) / 10kW (reverse phase)	
	Per Phase	5kW (3phase)	
Resolution	0.001kW		
Accuracy	< 0.4% + 0.4% F.S. (DC,16Hz ~ 500Hz)		

AC Mode	CS Mode			
	Range	Max. Power	15kVA (1phase/3phase) / 10kVA (reverse phase)	
		Per Phase	5kVA (3phase)	
	Resolution	0.001kVA		
	Accuracy	<0.4% +0.4% F.S. (16Hz ~ 500Hz)		
	CR Mode			
	Range	0.334 ~ 388.88Ω(1phase) / 1.002 ~ 1166.6Ω (3phase/reverse phase)		
	Resolution	0.001Ω		
	Accuracy *11	0.4%+0.4%F.S.		
	Circuit Emulation(CE)-Parallel rlc			
	R Range	0.334 ~ 388.88Ω(1phase) / 1.002 ~ 1166.6Ω(3phase/reverse phase)		
	L Range	1 ~ 2000mH (1phase) / 3 ~ 2000mH (reverse phase) / 3 ~ 2000mH (3phase)		
	C Range	0.001 ~ 9900uF (1phase) / 0.001 ~ 3300uF (reverse phase) / 0.001 ~ 3300uF (3phase)		
	Rc Range	0.334 ~ 388.88Ω(1phase) / 1.002 ~ 1166.6Ω(3phase/reverse phase)		
	RL Range	0.334 ~ 388.88Ω(1phase) / 1.002 ~ 1166.6Ω(3phase/reverse phase)		
	IL Range	0 ~ 272.7A (1phase) / 0 ~ 90.90A (reverse phase) / 0 ~ 90.90A (3phase)		
	Max peak current	272.7A (1phase) / 90.9A (reverse phase) / 90.9A (3phase)		
	Circuit Emulation(CE)-Rectifier single phase rlc			
	R Range	0.334 ~ 388.88Ω(1phase) / 1.002 ~ 1166.6Ω(3phase/reverse phase)		
	L Range	0.1 ~ 2000mH (1phase) / 0.3 ~ 2000mH (reverse phase) / 0.3 ~ 2000mH (3phase)		
	C Range	0.001 ~ 9900uF (1phase) / 0.001 ~ 3300uF (reverse phase) / 0.001 ~ 3300uF (3phase)		
	RS Range	0 ~ 388.88Ω(1phase) / 0 ~ 1166.6Ω(3phase/reverse phase)		
	Vcap Range	0 ~ 499.924V (1phase) / 0 ~ 499.924V (reverse phase) / 0 ~ 499.924V (3phase)		
	Vdiode Range	0 ~ 5V (1phase) / 0 ~ 5V (reverse phase) / 0 ~ 5V (3phase)		
	Max peak current	272.7A (1phase) / 90.9A (reverse phase) / 90.9A (3phase)		
	Phase Range			
	Range	Rectified Mode *12	-82.8°~+82.8°	
			-180° ~ +180°(Current Source Mode: +90.01° ~ +180° & -90.01° ~ -180°)	
	Resolution	0.01°		
	Accuracy*13	1% F.S.		
	CF setting			
	Range	1.414 ~ 5.0		
	Resolution	0.001		
	DC Mode	voltage range	30 ~ 499V(1phase) / 30 ~ 998V(reverse phase)	
		current range	0 ~ 90A (1phase) / 0 ~ 30A(reverse phase)	
current rise time		200us		
working mode		CC, CV, CR, CP, CC+CV, CR+CV, CP+CV, CC+CR, CC+CV+CP+CR		
Measurement parameter (grid simulator mode)				
Voltage RMS	Resolution	0.01V		
	Accuracy	<0.1%+0.1% F.S. (DC,16Hz ~ 500Hz) / <0.1%+(0.2%*kHz) F.S (500.01Hz ~ 2.4kHz)		
Current RMS	Resolution	0.01A		
	Accuracy	<0.1% + 0.2% F.S. (DC,16Hz ~ 150Hz) / <0.2% + 0.3% F.S. (150.01Hz ~ 500Hz) / <0.3% + (0.6%*kHz) F.S (500.01Hz ~ 2.4kHz)		
Peak current	Resolution	0.1A		
	Accuracy	<0.4% + 0.6% F.S. (16Hz ~ 500Hz) / <0.4% + (1.2%*kHz) F.S (500.01Hz ~ 2.4kHz)		
Output power	Resolution	0.001kW		
	Accuracy	<0.4% +0.4% F.S. (DC,16Hz ~ 500Hz) / <0.4% + (0.8%*kHz) F.S (500.01Hz ~ 2.4kHz)		
Harmonic measurement	Max.	50/60Hz	up to 50 orders	
Measurement parameter (electronic load mode)				
Voltage RMS	Range	0 ~ 350Vrms		
	Resolution	0.01V		
	Accuracy	<0.1%+0.1% F.S. (DC,16Hz ~ 500Hz)		
Current RMS	Range	0 ~ 90A		
	Accuracy	<0.1% + 0.2% F.S. (DC,16Hz ~ 150Hz) / <0.2% + 0.3% F.S. (150.1Hz ~ 500Hz)		
Peak current	Range	0 ~ 270A		
	Resolution	0.1A		
	Accuracy	<0.3% + 0.6% F.S. (16Hz ~ 500Hz)		
Active power	Range	0 ~ 15kW		
	Resolution	0.001kW		
	Accuracy	<0.4% +0.4% F.S.		
Reactive power	Range	0 ~ 15kVAR		
	Resolution	0.001kVAR		
	Accuracy	<0.4% +0.4% F.S.		
Apparent power	Range	0 ~ 15KVA		
	Resolution	0.001KVA		
	Accuracy	<0.4% +0.4% F.S.		
CF measurement	Range	1 ~ 5		
	Resolution	0.01		
PF measurement	Range	0.1 ~ 1		
	Resolution	0.01		
	Accuracy	1%F.S.		
Harmonic measurement	Max.	50/60Hz	up to 50 orders	

Regenerative		
Max. Regenerative power		15kVA
THD		< 5%
Others		
Efficiency	typ *14	91%
dimension		483.00mm (W) * 151.3mm (H) * 777.50mm(D) (841.6mm cover and holder included)
Weight		42kg
Working temperature		0 C -50 C
Programming response time		2ms
Remote Sense Compensation Voltage		20V
Communication interface		Built-in USB/CAN/LAN/Digital IO interface, optional GPIB / Analog&RS232

\*1 ( 200~220 ) ±10%, 3 phase AC input, power is 60% of the rated.

\*2 Depending on the frequency, the output voltage will decrease. The rated voltage can be output below 1.4kHz, the maximum output voltage at 2kHz is 250.76Vrms, and the maximum output voltage at 2.4kHz is 208.97Vrms.

\*3 When the output frequency is below 50Hz/60Hz, and the peak current is not exceeded, the maximum CF is 6; under the condition of full current and full power, the maximum CF is \*4  
When

\*4 loopSpeed Low is low it can better complied DUT's characteristics; When LoopSpeed is High, the dynamic response time is faster.

\*5 30kW and above models need to use the sense remote measurement mode for testing.

\*6 Test condition: pure resistive load, under full power condition

\*7 When the input frequency is below 50Hz/60Hz, and the peak current is not exceeded, the maximum CF is 5; under the condition of full current and full power, the maximum CF is 3.

\*8 For frequency <150Hz, the minimum current for accuracy test is 1%F.S., for frequency >150Hz, the minimum current for accuracy test is 3%F.S.

\*9 When LoopSpeed is Low, it is more adaptable to the load; when LoopSpeed is Fast, the dynamic response is faster; when the frequency is high, please use Fast mode.

\*10 Test frequency <150Hz, which meets this specification.

\*11 Under condition: I >10%F.S., F <150Hz

\*12 In rectifier load mode, the setting range of the phase angle is related to CF. The higher the CF, the wider the setting range.

\*13 ≤150Hz, 1%F.S., >150Hz, 5%F.S.

\*14 Test conditions: Input 380VLL/50Hz, output three-phase, each phase 350Vrms/50Hz/7kW.

All the above parameters are subject to change without prior notice from ITECH.

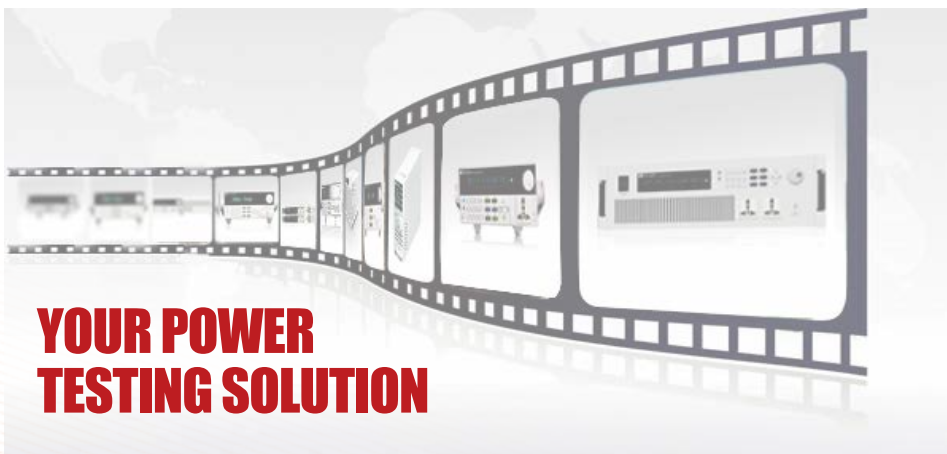

This information is subject to change without notice. For more information, please contact ITECH.

## Taipei

Add: No.918, Zhongzheng Rd., Zhonghe Dist., New Taipei City  
235, Taiwan

Web: [www.itechate.com](http://www.itechate.com)

TEL: +886-3-6684333

E-mail: [info@itechate.com](mailto:info@itechate.com)

## Factory I

Add: No.108, XiShanqiao Nanlu, Nanjing city, 210039, China

TEL: +86-25-52415098

Web: [www.itechate.com](http://www.itechate.com)

## Factory II

Add: No.150, Yaonanlu, Meishan Cun, Nanjing city, 210039, China

TEL: +86-25-52415099

Web: [www.itechate.com](http://www.itechate.com)



ITECH Web



ITECH Facebook



ITECH LinkedIn